

**ACEG10LSD1555CP
Self-Testing/Self-Diagnostic Emergency LED Driver**

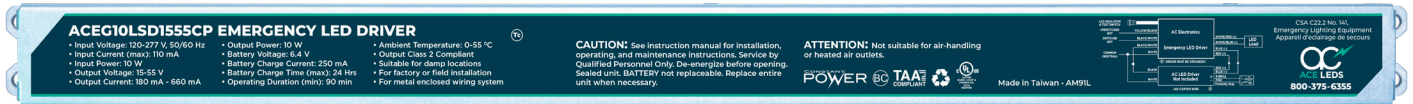

Primary Specifications:

Output Power Max	Input Power	Input Current Max	Emergency Operating Time	Battery	Input Voltage	Output Voltage	Ambient Operating Temperature	UL Listed for US and Canada
10 W	10 W	110 mA	90 min.	LiFePO ₄ 24 Hour recharge 7 to 10 year Life expectancy	120-277 Vac 50/60Hz	15-55 V ¹	0 °C through 55 °C	UL and cUL (UL924) Emergency LED Driver



Description:

The **ACEG10LSD1555CP** from ACE LEDS is a UL Listed Emergency LED Driver which features automated monthly and annual Self-Testing and Self-Diagnostics functionality. The **ACEG10LSD1555CP** enables the same LED fixture to be used for both normal and emergency operation. The **ACEG10LSD1555CP** contains a LiFePO₄ battery, a high-efficiency battery charger, control circuitry, and high-efficiency power converter circuits, in a single metal enclosure. The **ACEG10LSD1555CP** also includes the automatic power activate feature, which eliminates the external battery connector, where upon installation and initial power-up the **ACEG10LSD1555CP** automatically self-activates. In the event of a power failure of the normal supply, the **ACEG10LSD1555CP** switches

Additional Specifications:

- Normal (ac) driver maximum output current²:.....5 A
- Output current range³:.....180 mA to 660 mA
- Surge protection:.....3 kVp
- Maximum case temperature T_c:.....66 °C
- Ambient Temperature Operating Range:.....0 °C through 55 °C
- Storage time (max) and Storage Temperature:.....12 months (0 °C to 35 °C)
- Battery Type :LiFePO₄
- Nominal battery voltage:.....6.4 V
- Battery charge current:.....250 mA
- Metal enclosure IP rating:.....IP30
- Weight:.....1.54 lb
- Dimensions:.....16.53 in L x 1.2 in W x 1.1 in H 16.25" M

¹The emergency-mode output voltage operating range is 15-55 V for non-class 2 LED loads.
²The Normal (ac) Driver maximum output current is the maximum current allowed to pass through the **ACEG10LSD1555CP** circuitry in Normal-mode.
³The emergency-mode output current is automatically adjusted to maintain a constant output power across the output voltage range.
 * Warranty: 5 years based on a maximum case temperature of ≤ 60 °C, 3 years warranty based on a maximum case temperature of ≤ 66 °C

5-Year USA-Backed Warranty*
See complete AC Electronics/ACE LEDS Warranty information for details.

to emergency-mode and operates the fixture's LED load for 90 minutes or until normal power returns. The **ACEG10LSD1555CP** maintains the output power to the LED load at a constant 10 Watts, thereby maintaining a constant illumination level for the entire emergency runtime. When normal power returns, the **ACEG10LSD1555CP** returns to normal mode. The **ACEG10LSD1555CP** can be used in switched or unswitched fixture applications. The **ACEG10LSD1555CP** can drive any LED load in emergency-mode with a voltage range of 15-55 Vdc and that can operate at a current within the range of 180 mA to 660 mA. Self-Diagnostic status is communicated via the illuminated test switch LED indicator.

Safety and Regulatory Compliance:

- UL and cUL Listed as an Emergency LED Driver (UL924)
- UL Listed for both field and factory installation
- CE Title 20 compliant: Certified in CA Title 20 Appliance Efficiency Database – Battery Charger
- EMI: Complies to FCC commercial limits
- RoHS compliant
- UL and cUL Class 2 output (UL1310 compliant)

Features, Benefits, and Applications:

- Constant output power: Maintains constant emergency light levels over the full 90-minute runtime and over the output voltage range.
- Self-sensing output voltage: Automatically adjusts over the 15-55 V range to maintain constant power.
- Automatic Power Activate feature: Eliminates the external battery connector. Unit self-activates upon initial installation power-up.
- Includes input over voltage surge protection, output short circuit, open circuit, and over-voltage protection, as well as over-temperature protection for improved reliability.
- Two-wire universal input: Reduces wiring errors and reduces installation time and complexity.
- Includes a miniature illuminated test switch status indicator: Enables mounting in small spaces.
- Suitable for indoor and damp locations.
- Compatible with a variety of LED fixtures, such as emergency-only fixtures, as well as new and existing fixtures.
- Self-Testing/Self-Diagnostics: Monthly and annual self-testing feature satisfies the NFPA-101 periodic testing requirements and provides automatic Self-Diagnostic status indicated via the illuminated test switch LED indicator.
- Includes an isolated AC power relay which is used to provide a delay of the applied AC power to the normal AC LED DRIVER upon transition from emergency-mode to normal mode.

For questions or to place an order contact us at oemsales@aceleds.com or 800-375-6355 or your local WPG Americas Sales representative at inquiry@wpgamericas.com or 888-WPG8881



ACEG10LSD1555CP Self-Testing/Self-Diagnostic Emergency LED Driver

ACEG10LSD1555CP EMERGENCY LED DRIVER

- Input Voltage: 120-277 V, 50/60 Hz
- Input Current (max): 110 mA
- Input Power: 10 W
- Output Voltage: 15-55 V
- Output Current: 180 mA ~ 650 mA
- Output Power: 10 W
- Battery Voltage: 6.4 V
- Battery Charge Current: 250 mA
- Battery Charge Time (max): 24 Hrs
- Operating Duration (min): 90 min
- Ambient Temperature: 0-55 °C
- Output Class 2 Compliant
- Suitable for damp locations
- For factory or field installation
- For metal enclosed wiring system

CAUTION: See instruction manual for installation, operating, and maintenance instructions. Service by Qualified Personnel Only. De-energize before opening. Sealed unit, BATTERY not replaceable. Replace entire unit when necessary.

ATTENTION: Not suitable for air-handling or heated air outlets.

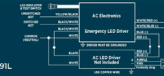

ESR-0223 With UL Emergency Lighting Equipment Approval & Enclosure for factors

800-375-6355

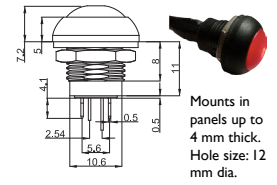
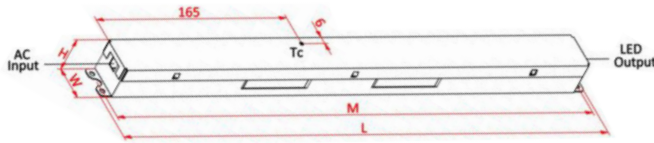

miniature illuminated test switch

Lead Lengths					
White	24"	Red	24"	Test Switch/LED Indicator	25"
Yellow/Black	24"	Blue	24"		6"
White/Black	24"	White/Red	24"		
White/Black	24"	White/Blue	24"		

Dimensions			
Length	16.53"	Height	1.1"
Width	1.2"	Mounting Length	16.25"

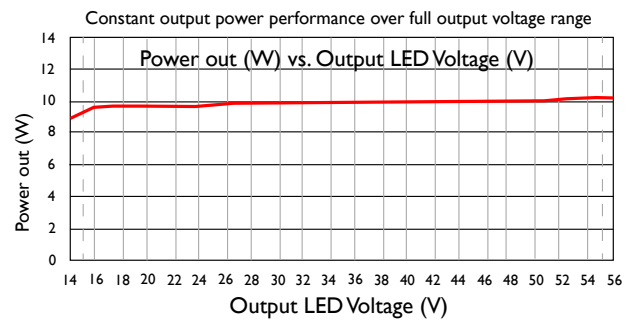
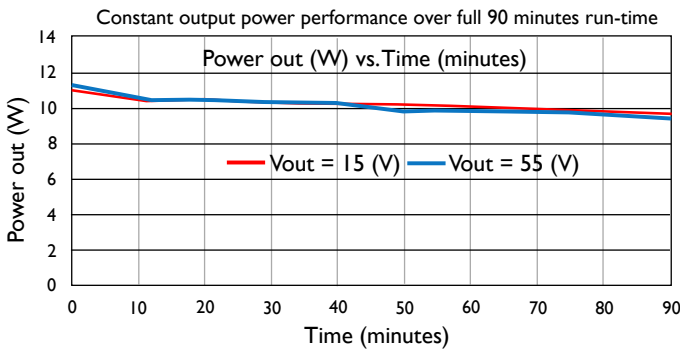

INSTALLATION:

The **ACEG10LSD1555CP** Emergency LED Driver with automated monthly and annual Self-Testing and Self-Diagnostics functionality may be used with either a switched or unswitched fixture. An unswitched (constant hot) lead must always be connected to this emergency LED driver to allow the battery to charge properly and to maintain a charge when normal AC power is available. The emergency LED driver must be fed from the same branch circuit as the normal AC LED driver (if used). This emergency LED driver must not be installed with fixtures where the ambient temperature may fall below 0 °C (32 °F), and it must be installed inside an electrical enclosure. The **ACEG10LSD1555CP** Emergency LED Driver comes in a

single metal enclosure with a separate miniature illuminated test switch status indicator. The **ACEG10LSD1555CP** includes the automatic power activate feature, which eliminates the external battery connector. Upon installation and first power-up the **ACEG10LSD1555CP** automatically self-activates. This emergency LED driver is suitable for installation in sealed and gasketed fixtures. The maximum remote mounting distance to the LEDs is 18 feet. The emergency LED driver metal case should be grounded. 18 AWG 600 V, 105 °C tinned stranded copper lead-wires are required for installation.

Specifications:

Emergency lighting shall be provided by using the AC Electronics **ACEG10LSD1555CP** Self-Testing/Self-Diagnostic Emergency LED Driver with a compatible LED fixture. The **ACEG10LSD1555CP** shall automatically test emergency lighting for a minimum of 30 seconds monthly and 90 minutes annually. The Self-Diagnostic status shall be indicated via the illuminated test switch LED indicator. The **ACEG10LSD1555CP** shall contain a LiFePO₄ battery with normal voltage of 6.4 V and 3600 mAh capacity, a high-efficiency battery charger, control circuitry, a high-efficiency two-wire universal input converter (120 through 277 Vac), high-efficiency output LED driver with soft-switching technology to prevent noise to protect LED modules and contained in a single metal enclosure. A separate miniature illuminated test switch LED status

indicator with installation hardware shall be provided for the purposes of manually performing or manually initiating periodic testing and indicate diagnostic status. The **ACEG10LSD1555CP** shall be capable of delivering a constant power of 10 Watts to an LED load of 15 - 55 V for a minimum of 90 minutes. The **ACEG10LSD1555CP** shall have a maximum of 10 Watts input power and shall comply with emergency standards established by the current NEC and shall meet CEC Title 20 (California Energy Commission) efficiency standards. The **ACEG10LSD1555CP** shall comply with part 15 of the FCC Rules. The **ACEG10LSD1555CP** shall be UL Listed for field and factory installation. The **ACEG10LSD1555CP** is suitable for indoor and damp locations.

For questions or to place an order contact us at oemsales@aceleds.com or 800-375-6355 or your local WPG Americas Sales representative at inquiry@wpgamericas.com or 888-WPG8881



ACEG10LSD1555CP Self-Testing/Self-Diagnostic Emergency LED Driver

Self-Diagnostic and Self-Testing Function:

The ACEG10LSD1555CP will automatically perform a 30-second test every 30 days, and automatically perform an annual test for a minimum of 90 minutes.

Self-Diagnostic Codes:

The LED indicator is a bi-color (red & green) indicator. Code flashes occur every 10 seconds.

Status Indication	Condition
Steady Green	Battery is Fully Charged
Flashing Green	Battery is charging
Off	Emergency-mode
One Red Flash	Charging Failure
Two Red Flashes	Battery Failure
Three Red Flashes	Load Failure

Manual Testing:

Manual testing can be performed by pressing the test switch. The failure code will be the same Self-Diagnostic Code shown on this page. Please follow the Manual Test Sequence table below.

Manual Test Sequence Table:

Manual Test Item	Test Switch Operation
Quick Test	Press and Hold During Charging
30-Second Test	2 X Press and Release
90-Minute Test	3 X Press and Release
Cancel 90-Minute Test	1 X Press and Release
Sleep Mode*	Press and <u>Hold</u> for 2 seconds when AC power is off or the unit is not connected to AC power

* Sleep Mode deactivates the unit and internally disconnects the battery to prepare the unit for storage prior to installation. The Automatic Power Activate feature will reactivate the unit upon installation and first power-up.

REFER ANY SERVICING INDICATED BY THESE CHECKS TO QUALIFIED PERSONNEL!

For questions or to place an order contact us at oemsales@aceleds.com or 800-375-6355 or your local WPG Americas Sales representative at inquiry@wpgamericas.com or 888-WPG8881

Typical wiring diagram for switching the switched hot AC power for the normal AC LED Driver

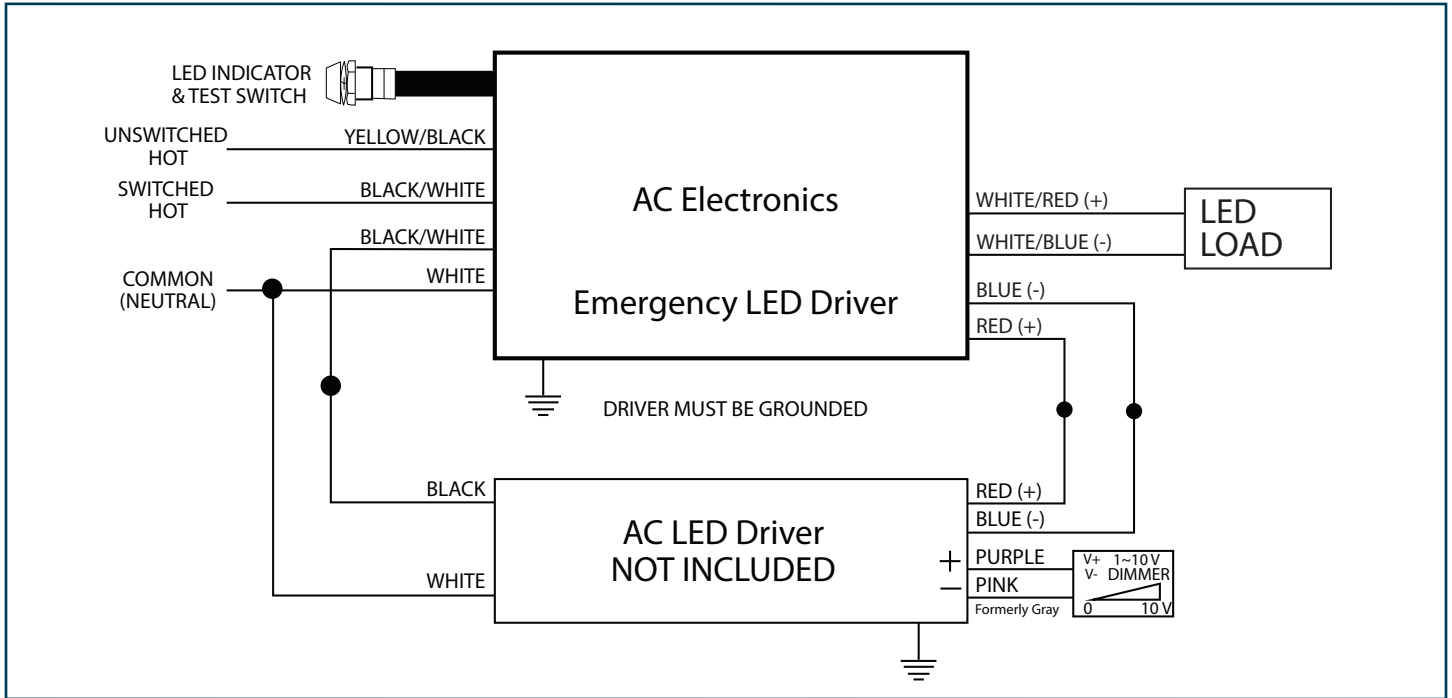

*AC Electronics/ACE LEDS warrants to the purchaser that each Emergency LED Driver will be free from defects in material or workmanship for a period of 5 years when operated at max case temp of up to <60°C when properly installed and under normal conditions of use. See aceleds.com for complete warranty policy.

For questions or to place an order contact us at oemsales@aceleds.com or 800-375-6355 or your local WPG Americas Sales representative at inquiry@wpgamericas.com or 888-WPG8881