

Constant Current LED Driver

Model Number:
AC-50CD1.4APNZ

Input Voltage: 120-277V
Input Frequency: 50/60Hz
Side and Bottom Mount/Leads Options
< 1 Sec. Start time/(Starting with batch code AKT.48)



**Programmable, Digital,
Wide-Range Adjustable Current & Dimming**

Electrical Specifications:

Output Power Max	Input Power	Input Current	Min PF (full load)	Max THD (full load)	Output Voltage	Output Current	T case Max	Min, Starting Temp**	Efficiency Up To	IP Rating	Dimming Protocol	Dimming Range
50W	60W	0.5A @ 120V 0.22A @ 277V	>0.90	<20%	15 to 55V	400 to 1400mA	90°C	-40°C	85%	64	0 to 10V	1 to 100%

** This driver can operate down to -40°C in a non-dimming condition. Below 0°C some flicker may be observed.

WIRING:

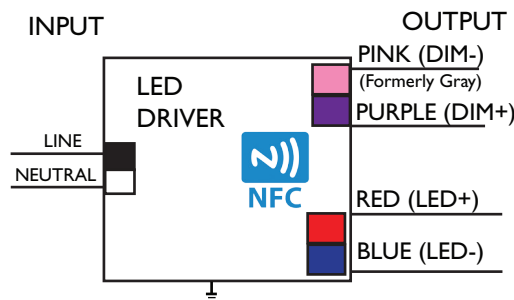

Note: Gray (-) dimming wire has been changed to pink per the 2020 NEC section 410.69 and NEMA.

Lead Lengths

Black	5.9"	Blue	5.9"	Purple	7.1"
White	5.9"	Red	5.9"	Pink	7.1"

PHYSICAL:

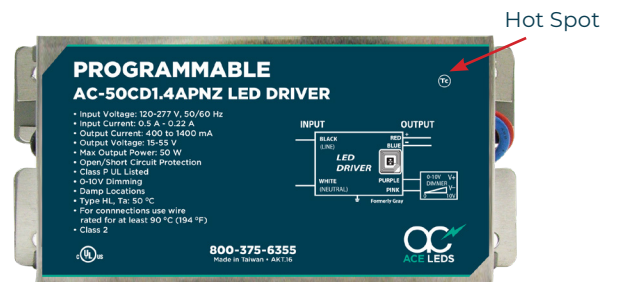

Dimensions	Length	Width	Height	Mounting
AC-50CD1.4APNZ	5.23"	2.48"	1.18"	4.84"

Tref Max Value (°C)	Tc/Tref Value (°C)	Ta/Value (°C)
90	61.7	40

SAFETY:

- Class A sound rating
- Overload Protection
- Open/Short Circuit Protection
- Input/Output Isolation
- Class P
- Class 2
- LED driver has a life expectancy of 50,000 hours at Tcase of ≤75°C
- LED driver has a life expectancy of 100,000 hours at Tcase of ≤65°C
- Warranty: 5 yrs based on max case temp of <75°C; 3 yrs based on max case temp of 90°C*
- FCC Title 47 CFR Part 15
- Surge Protection (2 KV)
- Gray (-) dimming wire has been changed to pink per the 2020 NEC section 410.69 and NEMA.

INSTALLATION:

- Max Remote installation distance is 18 ft
- LED driver cases should be grounded
- LED drivers shall be installed inside electrical enclosures
- 18 AWG 600V/105C tinned stranded copper lead-wires are required for installation



*AC Electronics/AC LED Power Designs warrants to the purchaser that each LED Driver will be free from defects in material or workmanship for a period of 5 years when operated at max case temp of up to <75°C; 3 years from date of manufacture when operated at a max case temp of up to 90°C when properly installed and under normal conditions of use. See aceleds.com for complete warranty policy.

For questions or to place an order contact us at oemsales@aceleds.com or 800-375-6355 or your local WPG American Sales representative at inquiry@wpgamericas.com or 888-WPG8881

IOUT/VOUT CURVE

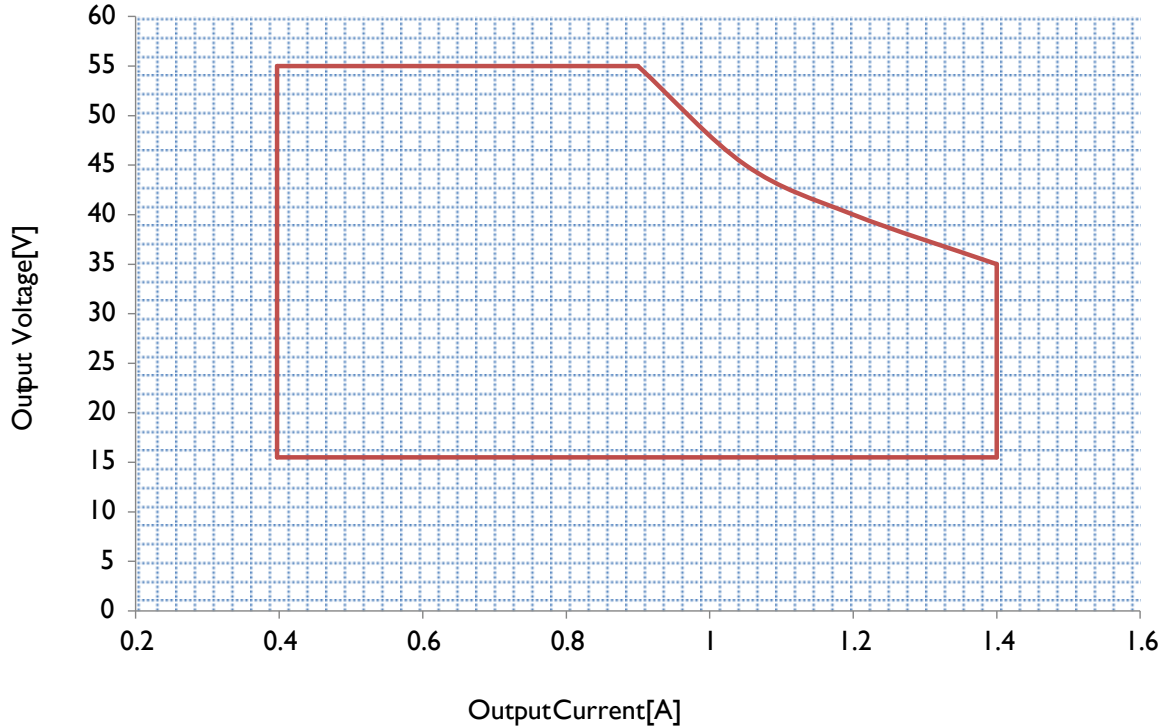

CONTROL THE IOUT WITH THE PROGRAMMING WAND. DOWNLOAD SOFTWARE FROM <http://www.aceleds.com/programmable.php>

Life Time v.s. Case Temperature Curve

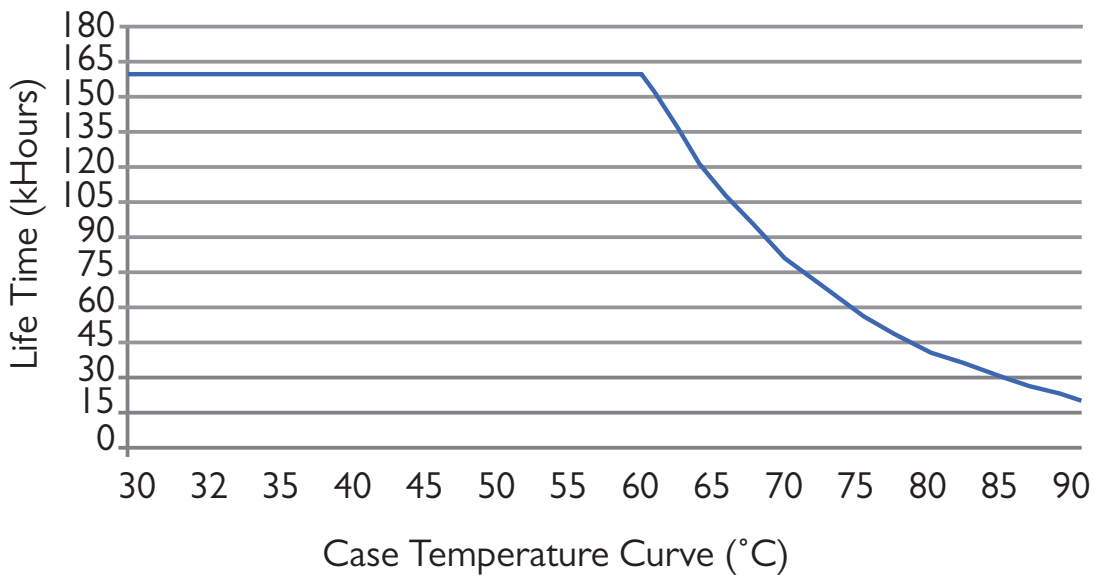

For questions or to place an order contact us at oemsales@aceleds.com or 800-375-6355 or your local WPG American Sales representative at inquiry@wpgamericas.com or 888-WPG8881

PERFORMANCE CHARACTERISTICS

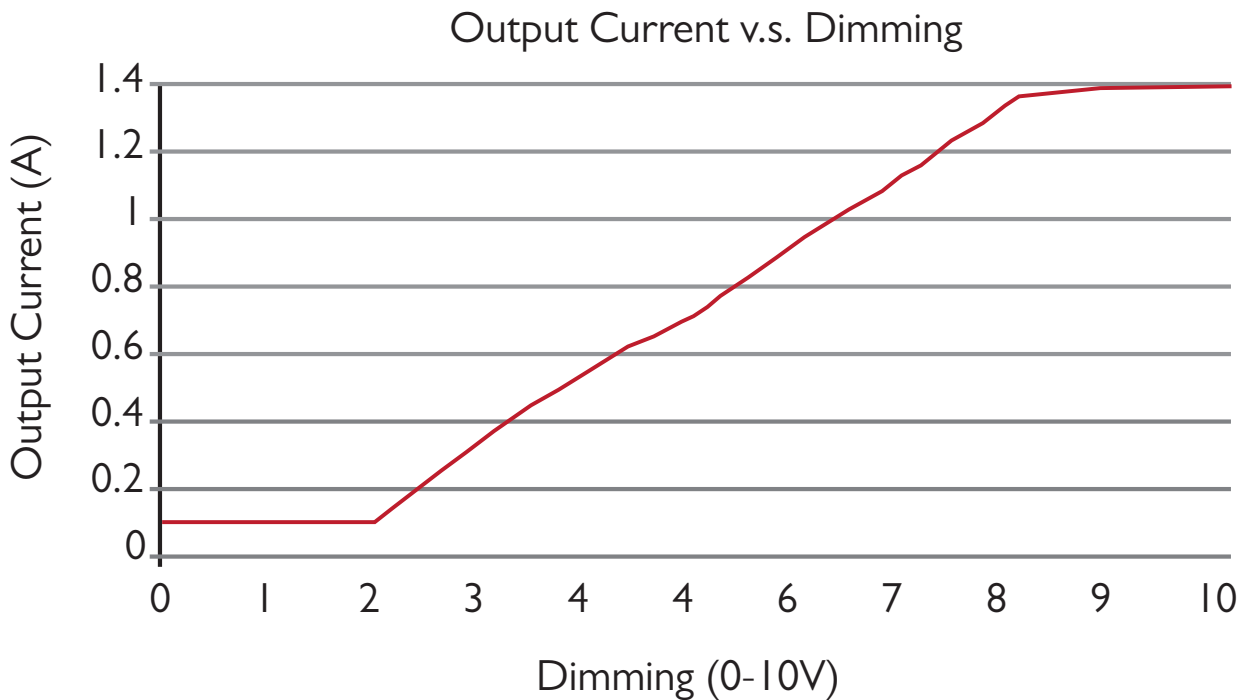
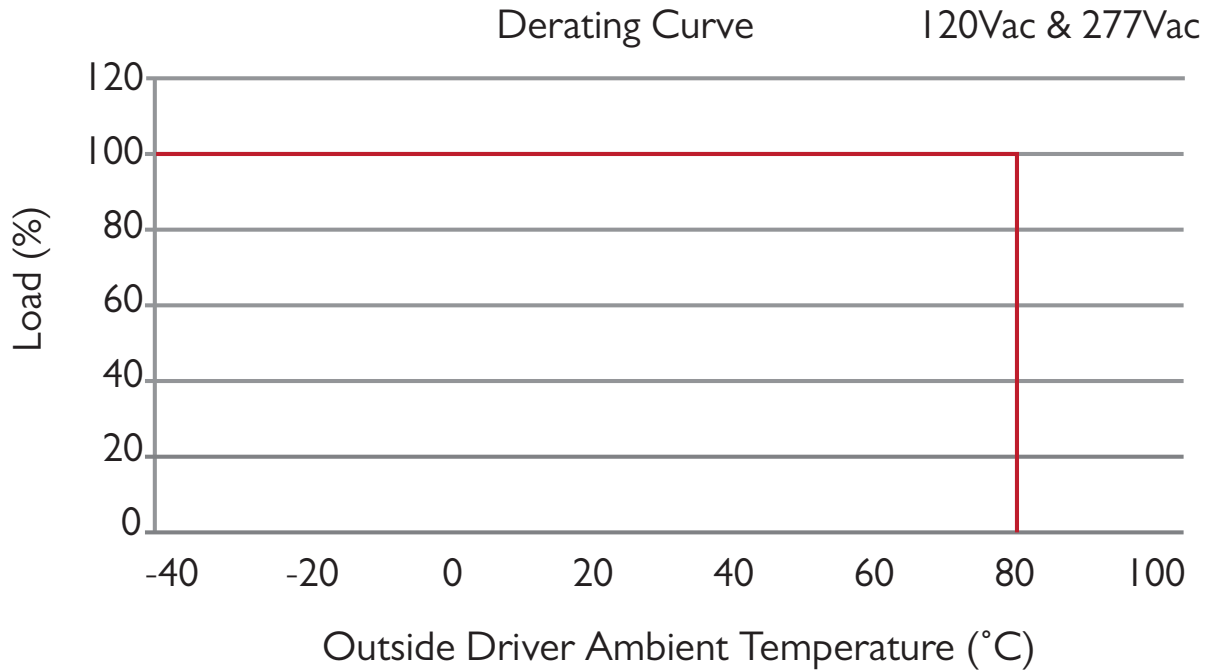

For questions or to place an order contact us at oemsales@aceleds.com or 800-375-6355 or your local WPG American Sales representative at inquiry@wpgamericas.com or 888-WPG8881

PERFORMANCE CHARACTERISTICS

Efficiency v.s. Load

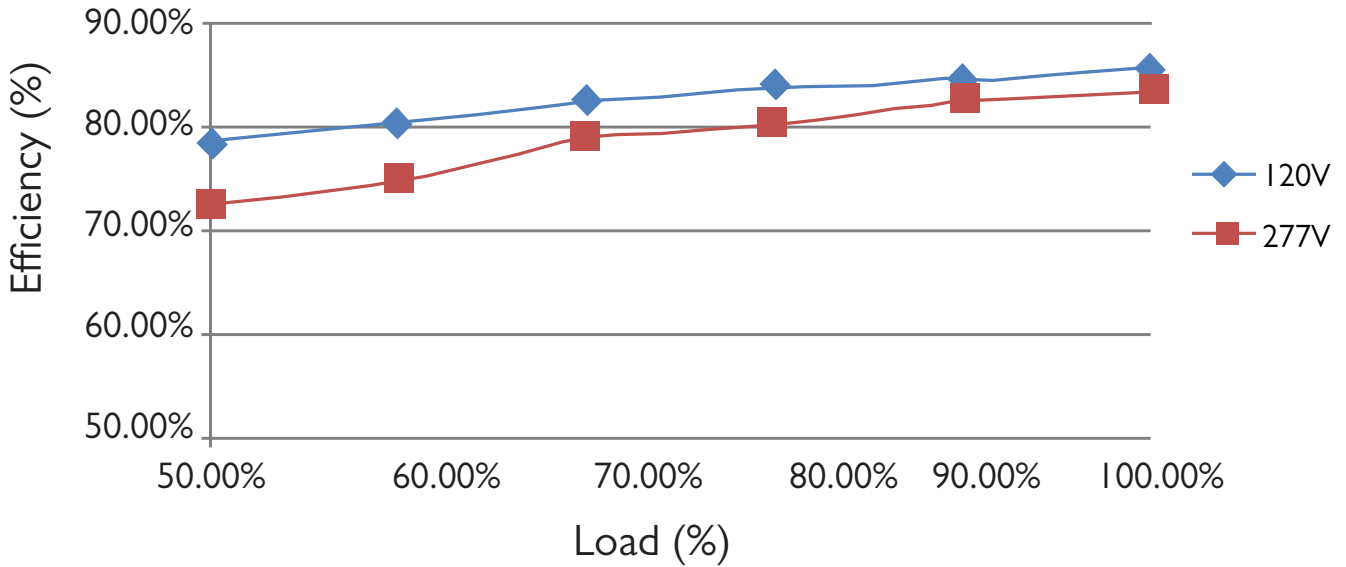

Power Factor v.s. Load

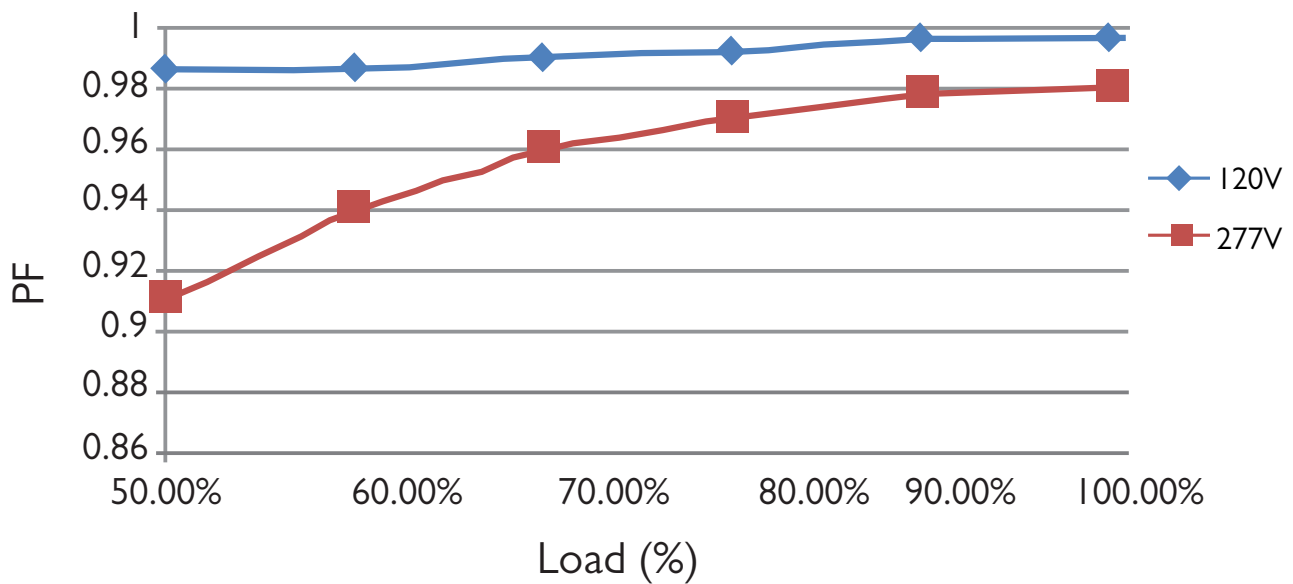

For questions or to place an order contact us at oemsales@aceleds.com or 800-375-6355 or your local WPG American Sales representative at inquiry@wpgamericas.com or 888-WPG8881

PROGRAMMABLE DRIVER OPTIONS (APP NOTE)

Put the programmable wand above the NFC mark of the driver to start programming

CONTROL THE IOUT WITH THE PROGRAMMING WAND. DOWNLOAD SOFTWARE FROM <http://www.aceleds.com/programmable.php>



All programmable drivers accept a 16-bit hexadecimal code to program the output current (Iout) of the driver. The Iout programming codes are documented in the computer based-programming software (ST-TOOLS.exe) or from the driver's IOUTCODE.pdf file. The Locations below 0, 1, 2, 3 contain the basic code for a specific output current value (example 84 03 00 01 = 1050 mA for AC-50CD1.4APNZ).

Location | 0 | 1 | 2 | 3 |

Value | 00 | 00 | 00 | 00 |

For drivers containing Revision C of their firmware (contact factory for date code of implementation), it is also possible to adjust the minimum dimming level and the dimming speed. This adjustment is made by modifying location 2 of the programming code while keeping the other locations set for the desired output current. Specifically, the location 3 values are defined as:

- 00 => Dim to 1%, Speed \leq 1.0 sec
- 01 => Dim-To-OFF, Speed \leq 1.0 sec
- 02 => Dim to 10%, Speed \leq 1.0 sec
- 03 => Dim to 1%, Speed \geq 2.5 sec
- 04 => Dim-To-Off, Speed \geq 2.5 sec
- 05 => Dim to 10%, Speed \geq 2.5 sec

As an example, if the programming code value of 84 03 00 01 is programmed, the output current will be 1050 mA, and the driver will dim to 1% and the dimming speed will be \leq 1.0 sec. If the programming code of 84 03 04 01 is programmed, the output current will be 1050 mA, and the driver will dim to off and the dimming speed will be \geq 2.5 sec.

For questions or to place an order contact us at oemsales@aceleds.com or 800-375-6355 or your local WPG American Sales representative at inquiry@wpgamericas.com or 888-WPG8881